

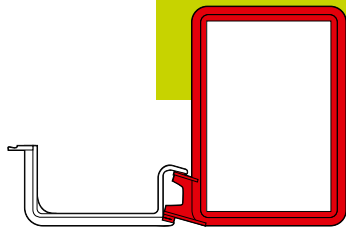

# SHELF EQUIPMENT



## SHELF EQUIPMENT

### KLICK SHELF BARKERS

#### KLICK SHELF BARKER

Made of premium, unbreakable plastic with rear Klick adaptor. The fastening elements (see Klick accessories) are inserted into the dovetail guide on the rear of the barker and locked securely into place with an audible "Klick".

Available in OEK standard colors, clear and silver. Gold and chromium are available upon request.

A9	13090-xx	148 x 70 mm	13004-xx
A8	13080-xx	210 x 59 mm	13003-xx
A7	13070-xx	210 x 74 mm	13002-xx
A6	13060-xx	210 x 99 mm	13001-xx

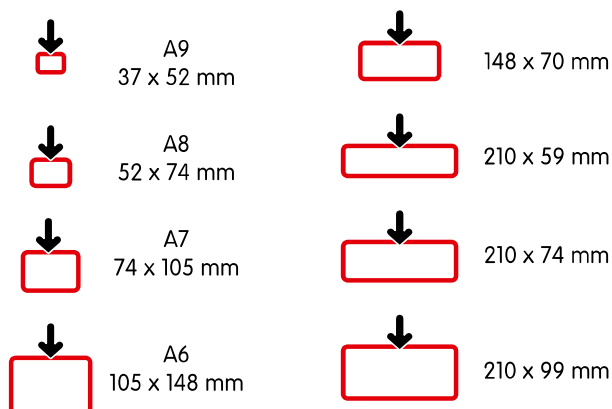

The wide range of **Oechle Klick accessories** offers various fastening possibilities. You will find an overview on the following catalogue pages.



#### KLICK ACRYLIC BARKER

The alternative to bring your message "crystal clear" to customers' attention. The print is completely covered and protected, without distracting lines or colors, clear. With "dovetail" adaptor on the rear to suit Klick accessories.

A8	13580-25
A7	13570-25
A6 portrait	13561-25
A6 landscape	13560-25
148 x 70 mm	13504-25

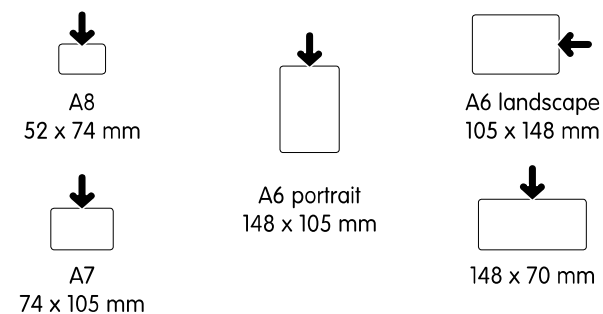

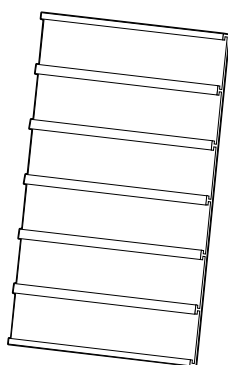

**KLICK LABEL HOLDER EXTRA**  
 For insert of 6 labels, size 110 x 26 mm, max. thickness 0,9 mm, with Klick adaptor on the rear. External size: 110 x 175 mm. Colors: white, grey, anthracite.

EXTRA without support | 13300-xx  
 EXTRA with support (grey) | 36500-03



**EXTRA PVC COVER (SET)**  
 To cover labels, made of PVC with 0,4 mm thickness, non-reflective, clear. Size: 110 x 26 x 0,4 mm. PU: 60 pcs. per set.

24142-00



**CHALK BOARDS**  
 Made of polystyrene, both sides slate coated, for showcard frames of same size, thickness 0,95 mm, rounded edges, black. Other sizes available upon request.

**Attention: These chalk boards are not heat-resistant. It is not excluded that they get deformed e.g. by direct solar irradiation. For heat-resistant chalk boards please see page 194.**

A8 | 30012-A8/095  
 A7 | 30012-A7/095  
 A6 | 30012-A6/095

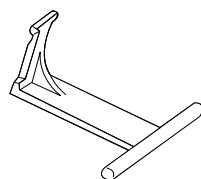

**SUPPORT**  
 Frame support and distance holder, colors: clear, white.

23750-xx



## SHELF EQUIPMENT

### KLICK ACCESSORIES (SERIES 300)



#### HOOK CLIP Ø 10 MM

For wire baskets, containers, etc., fits wires up to Ø 10 mm. For baskets with a sloping wire front we recommend to use support (23750-xx) as distance holder, white.

23300-26

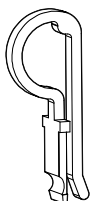

#### SUSPENSION HOOK FRUITS & VEGETABLES

To suspend price cassettes and Klick shelf barkers from horizontal tubes and relings with Ø 12 mm, used mainly in fruit- and vegetable applications, white.

23015-26

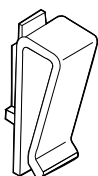

#### FASTENER FOR VERTICAL GLASS PANELS

Fits panels with up to 6 mm thickness, white.

23320-26



#### FASTENER FOR VERTICAL METAL PLATES

Fits thin metal shelving with upright front edge or similar, white.

23330-26

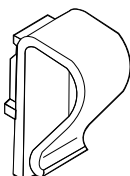

#### HOOK CLIP Ø 20 MM

For wire baskets, fine tubes etc. with Ø up to 20 mm, white.

23310-26

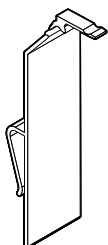

#### CARDBOARD CLAMP 10

To attach Klick shelf barkers, price cassettes, etc. to cartons or boxes with up to 10 mm thickness, clear.

23710-00



#### KLICK CARDBOARD CLAMP 20

To attach Klick shelf barkers, price cassettes, etc. to containers, trays and baskets with up to 20 mm thickness, clear.

23715-00



## SHELF EQUIPMENT

### KLICK ACCESSORIES (SERIES 300)

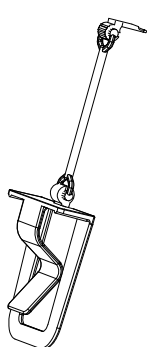

**NEW**

**CARDBOARD CLAMP 70 WITH FK ROD**  
To attach to baskets, boxes or similar with up to 18 mm thickness. Set consisting of cardboard clamp 70 and FK rod with Klick adaptor, to be used with price cassettes, Klick frames, acrylic frames, electronic shelf labels and others. Color: black. Other colors are available upon request.

with rod 50 mm		35492-10/050
with rod 100 mm		35492-10/100
with rod 200 mm		35492-10/200

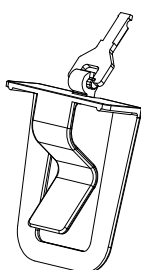

**NEW**

**CARDBOARD CLAMP 70 WITH FK CONNECTOR 25**  
To attach to baskets, boxes or similar with up to 18 mm thickness. Set consisting of cardboard clamp 70 and FK connector 25. Color: black. Other colors are available upon request.

35490-10

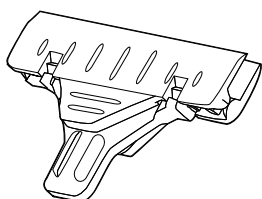

**CLAMPHOLDER**  
Clampholder with Klick adaptor and clamp 100 mm wide to take signs, cartons, etc. with up to 5 mm thickness, clear. To be used with the Klick accessories range.

17060-00

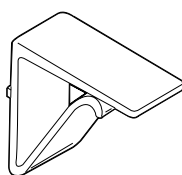

**FASTENER FOR LEDGES**  
For ledges, boards and shelves with up to 10 mm thickness, white.

23160-xx

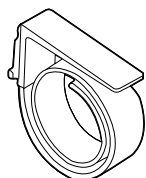

**COIL-SPRING FASTENER**  
For tables, shelves etc., with up to 60 mm thickness, 1-part, white.

23100-26

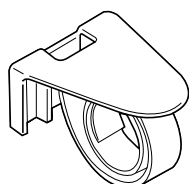

**FASTENER WITH COIL-SPRING**  
Massive and stable fastener for tables, shelves etc., with up to 60 mm thickness, 2-parts, coil-spring white, upper part clear.

23110-26



## SHELF EQUIPMENT

### KLICK ACCESSORIES (SERIES 300)

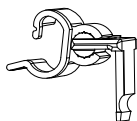

**KLICK ADAPTOR WIRE TECH 100**  
Swiveling holder with Klick adaptor 2-parts mounted. To be used on wire shelves Wire Tech and Wire Tech 100 (Wanzl). Inclination angle quintuplicately adjustable. Colors: grey/clear, black/clear and black/black.

23090-xx

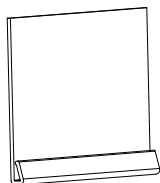

**L-RAIL**  
L-rail with adhesive, suitable to Klick rail adaptor small & large. Colors: white, green.

shelf length 1000 mm | 23690-xx

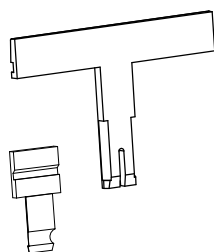

**KLICK RAIL ADAPTOR**  
Adaptor to insert into L-rail, suitable to all elements of Klick range (series 300). Color: clear.

small | 23693-00  
large (available upon request) | 23695-00

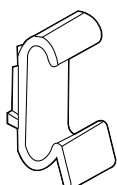

**CLIP FASTENER FOR TEGOMETALL SHELVES**  
For an inclined presentation, white.

23610-26

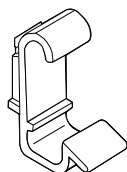

**CLIP FASTENER FOR LINDE SHELVES**  
For a 90° presentation, white.

23620-26

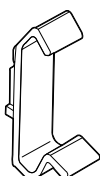

**CLIP FASTENER FOR TICKET RAIL 40 MM**  
Clips outside, white.

23640-26

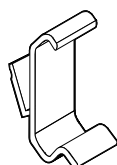

**CLIP FASTENER FOR TICKET RAIL 40 MM/15°**  
Clips outside with a 15° presentation angle, white.

23650-26



## SHELF EQUIPMENT

### KLICK ACCESSORIES (SERIES 300)

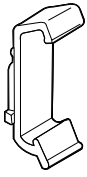

CLIP FASTENER FOR TICKET RAIL 26 MM  
Clips outside, white.

23630-26



CLIP FASTENER FOR TICKET RAIL 50 MM  
Clip for attaching click frames, price cassettes, etc. on ticket rails 50 mm, clips outside, white.

23661-26

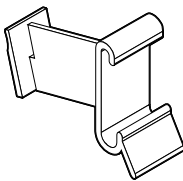

PENDULUM CLIP FASTENER FOR  
TEGOMETALL SHELVES  
Clip with longer arm, made of flexible  
plastics, white.

23600-26

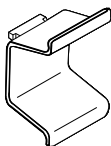

CLIP FASTENER FOR TICKET RAIL  
Up to 30 mm, clips inside, white.

23540-26

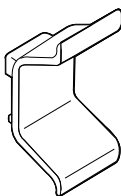

CLIP FASTENER FOR TICKET RAIL  
Up to 40 mm, clips inside, white.

23560-26

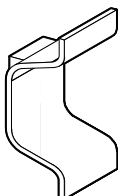

CLIP FASTENER FOR TICKET RAIL  
Up to 50 mm, clips inside, white.

23570-26

## SHELF EQUIPMENT

### KLICK ACCESSORIES (SERIES 300)

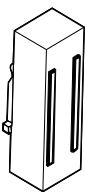

#### MAGNETIC FASTENER VERTICAL

Magnetic fastener for a quick attachment of shelf barkers to metal shelves or any other metallic equipment. Magnetic force up to approx. 2,8 kgs. Colors: clear, white, grey.

23220-xx

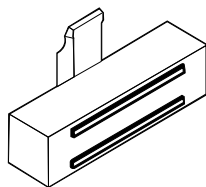

#### MAGNETIC FASTENER HORIZONTAL

Magnetic fastener for a quick attachment of Klick barkers to metal shelves or any other metallic equipment. Magnetic force up to approx. 2,8 kgs, clear.

23225-00

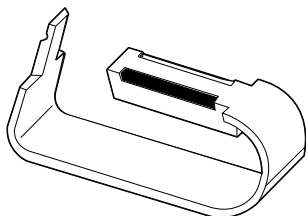

#### MAGNETIC SWING FASTENER

The Klick barker is attached to the shelf etc. from below, magnetic force up to approx. 2,8 kgs. Can be pressed downwards to make the EAN label readable, white.

23125-26

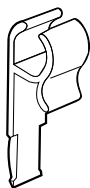

#### CLAW FASTENER

For wire baskets, wire-lattice etc., fits wires up to Ø 5 mm, white.

23410-26

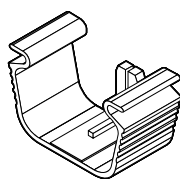

#### CLIP FOR WIRE BASKETS

Suits wire baskets, shelves, etc., for wires with distance of up to 40 mm and wire-Ø 2 - 5 mm, white.

26040-26

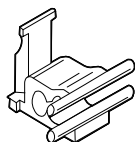

#### SLOPING FASTENER

For horizontal wire shelving and shelf baskets with sloping front, fits wires up to Ø 5 mm, white.

23400-26

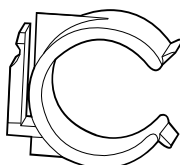

#### TUBE CLIP

For sales stands, cloths racks, tables etc., fits tubes with Ø 23 - 28 mm, white.

23500-26





## SHELF EQUIPMENT

### KLICK ACCESSORIES (SERIES 300)

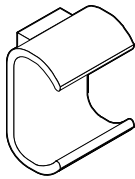

OVAL TUBE CLIP  
Fits oval tubes 15 x 30 mm, clear.

23510-00

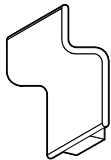

SLATWALL-CLIP  
For slatwalls, white.

23780-26



FASTENER FOR PEG BOARD HOOKS  
With locking function to secure a certain viewing angle, 2-parts, color: transparent.

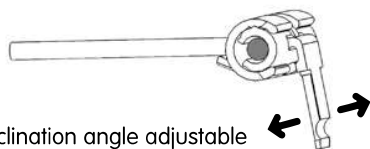

Inclination angle adjustable

VERSION "A"  
For hooks with **front wire** (e.g. Geck, ZOK and partly TEGO).

28718-00A

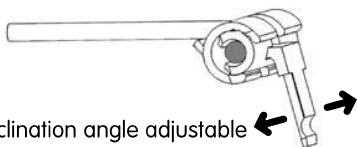

Inclination angle adjustable

VERSION "B"  
For hooks with **bottom wire** (e.g. Hohage, Wanzl and TEGO).

28718-00B

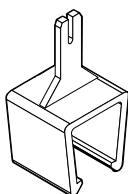

FASTENER FOR MINIKOMET SALES STAND  
For fastening Klick barkers, etc. onto horizontal square tubes 21,2 x 21,2 mm, clear.

23460-00

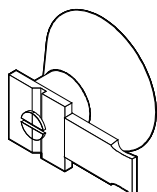

SUCTION CUP  
For a quick attachment of Klick barkers, etc. to smooth surfaces, such as glass etc., clear.

23700-00

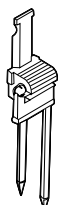

PIN HOLDER SWIVEL-TYPE  
To fix price and product information directly on the product, e.g. in wool, white.

23830-26



## SHELF EQUIPMENT

### KLICK ACCESSORIES (SERIES 300)



METAL STICKPIN  
With stainless steel needle.

23820-00

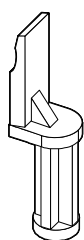

KLICK TUBE ADAPTOR  
To connect Klick barkers, etc. to chromium tubes, Ø 10 mm, grey. For suitable tubes please see chapter "Components".

23810-03

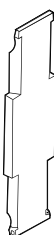

CONNECTOR  
To connect several Klick barkers, price cassettes, etc., clear.

23010-00

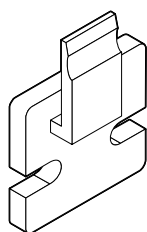

WALL FASTENER  
For an invisible wall fastening of Klick barkers, available for screw fixing or with double adhesive tape, clear.

screw mounting | 23130-00  
with double | 23131-00  
adhesive tape

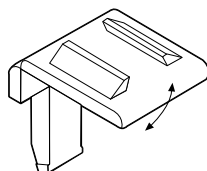

HINGED ADAPTOR  
With film hinge, swivel-type, clear.

23140-26

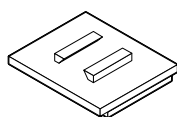

ADHESIVE PLATE (29 X 35 MM)  
With double adhesive foam tape. Sticks onto cards, chalk boards etc., suits Klick accessories, white.

23150-01





SWIVEL HINGE

To fix Klick barkers in an inclined angle in connection with the FK connector and different elements such as fastener for ledges, fastener with coil-spring, transparent.

23815-00



ADAPTOR FOR OEK KLICK ACCESSORIES WITH CASSETTES OF OTHER PRODUCERS

For fixing cassettes or frames of other producers with OEK Klick accessories (series 300), black.

23013-10



ADAPTOR FOR OEK KLICK FRAMES ONTO ACCESSORIES OF OTHER PRODUCERS

For fixing OEK Klick frames, qP price cassettes, etc. onto accessories of other producers, white.

23012-01



KLICK BOTTLE HOLDER

Fits onto all PET bottles (1,5 L - 1,0 L - 0,5 L), with rear Klick adaptor to hold qP price cassettes, shelf barkers, etc., colors: clear, grey.

20026-xx



VISIONLINE KLICK ADAPTOR WITH CLAMP "VISION 58"

Using the Klick adaptor, all price cassettes and Klick shelf barkers can be combined with the range of Visionline elements. Set consisting of Visionline Klick adaptor (white) and clamp Vision 58 (clear).

28437-00



## SHELF EQUIPMENT

### SHOPPER STOPPERS

#### SHOPPER STOPPERS & BANNER HANGERS

Considered as real attention-grabbers our swivel frames, shopper stoppers and banner hangers are ideal for the price marking directly at the shelf. They will guide your customers straight to new products and special sales promotions.

We offer a wide range of product variants and fixing possibilities which are suitable for all common types of shelving.

#### Remark:

In need of any other colors?

If you order at least 1.000 pieces, we should be happy to produce the swivel-type frames in any of our OEK standard colors. In this case, however, we reserve the right to make an overdelivery or underdelivery of +/- 10%.

#### SHOPPER STOPPER WITH SWIVEL-CARDHOLDER

With square magnet, magnetic force up to 5,6 kgs, swivel-arm in standard short or long version white, clear swivel-cardholder 35 mm to take signs, etc. with up to 0,5 mm thickness.

short (L = 65 mm)		33909-00/01
long (L = 85 mm)		33911-00/01

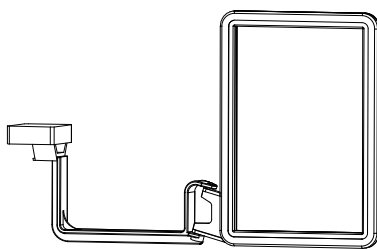

#### SHOPPER STOPPER WITH SWIVEL FRAME

For fixing onto metal shelving, magnetic force up to 5,6 kgs, due to gravity the frame swivels back 90° to the shelf, swivel arm (L = 65 mm) and magnet in white. Frame colors: white, red, grey upon request.

A6 landscape		33956-xx
A6 portrait		33966-xx
A5 portrait		33913-xx
A5 landscape		33914-xx



#### SHOPPER STOPPER WITH LONG ARM (85 MM) AND SWIVEL FRAME

With a longer arm especially suitable for metal shelving with integrated lighting, swivel arm and magnet in white. Frame colors: white, red, grey upon request.

A6 landscape		33957-xx
A6 portrait		33967-xx



#### SHOPPER STOPPER WITH SHORT ARM (65 MM) WITH SWIVEL FRAME AND CLIP FOR WIRE BASKETS

To fix to metal wire shelving, suitable for wire distances up to 40 mm with a wire Ø of 2 - 5 mm, swivel arm and wire clip in white. Frame colors: white, red, grey upon request.

A6 landscape		33976-xx
A6 portrait		33986-xx



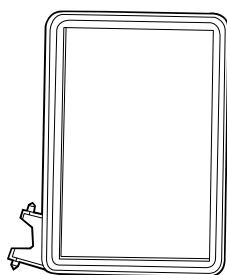

**SWIVEL FRAME**

Frame always swivels back in 90° position to the shelf by gravity, to be mounted with swivel arm and different fixing accessories (as described below in detail). Colors: white, red, grey upon request.

A6 portrait		16666-xx
A6 landscape		16656-xx
A5 portrait (series 100)		16502-xx
A5 landscape		16501-xx

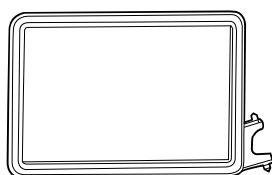

**SWIVEL ARM**

Connecting element between swivel frame and fixing accessories, white. Longer version especially suitable for shelves with integrated lighting.

short (L = 65 mm)		26070-01
long (L = 85 mm)		26071-01

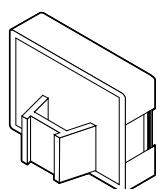

**RS MAGNET (32 X 38 MM)**

Magnetic holder to take swivel arm, magnetic force up to 5,6 kgs, white.

26230-01

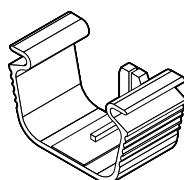

**RS CLIP FOR WIRE BASKET**

Suitable for wires with a distance of up to 40 mm, wire Ø of 2 - 5 mm, white. Also to be used as Klick accessory part.

26040-26

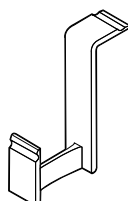

**KLICK RS ARM**

To fix Klick frames e.g. to shelves with adhesive plate, RS-magnet, wire clip etc., white.

26060-01



## SHELF EQUIPMENT

### SHOPPER STOPPERS

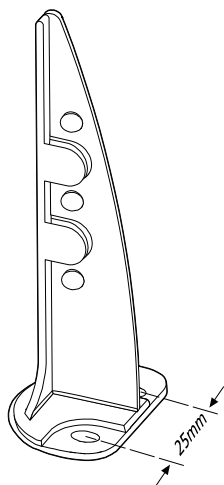

#### SHOPPER STOPPER FOR SHELIVING

Suitable for Yudigar and Kider shelves with rectangular (5 x 10 mm) and rhomboid shaped (5 x 5 mm) holes, incl. 2 fixing clips, to clamp special poster pocket 3-hole, clear.

with square holes | 17411-00

Suitable for CEFLA shelves with holes Ø 7 mm, incl. 2 fixing clips, to clamp special poster pocket 3-hole, clear.

with round holes | 17410-00



#### FIXING CLIPS

For fixing of above shopper stoppers, clear.  
PU: 1 bag containing 100 pcs.

round | 49098-26-M/6,8  
square | 49098-26-M/5x5

#### SHOPPER STOPPER WITH ROUND MAGNET

For use on metal shelving with magnet Ø 50 mm, magnetic force up to approx. 18 kgs., clear. To clamp 3-hole poster pocket. Available upon request.

17420-00



#### SHOPPER STOPPER WITH SUCTION CUP

For use on glass or metal shelving, suction cup Ø 36 mm, clear. To clamp 3-hole poster pocket.

17430-00

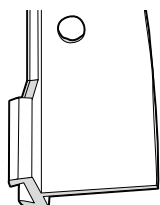

#### SHOPPER STOPPER KLICK

With Klick adaptor, to suit all fastening elements of Klick series 300 accessories, clear.

17441-00



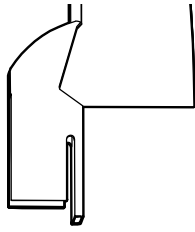

**SHOPPER STOPPER PRIMA**  
Suitable to mount onto shelf dividers standard type 1 and 2 with height 60 and 120 mm, clear.

17440-00

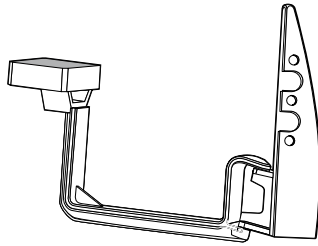

**SHOPPER STOPPER SWIVEL-ARM WITH MAGNET, 3-PART**  
For use on metal shelving, to clamp special poster pocket 3-hole. Set consisting of white square magnet, magnetic force up to 5,6 kgs, with long swivel-arm white (L=85 mm) and shopper stopper clear.

28005-00/01

**POSTER POCKET 20 X 20 CM WITH 3-HOLE**  
To be used with shopper stoppers described above, with 3 clamp holes for a secure and tight fit, made of non-reflecting PVC, clear.

29600-0007/04

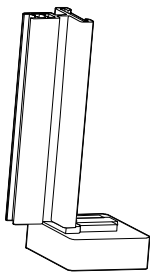

**SHOPPER STOPPER SUPERGRIP WITH MAGNET, 3-PART**  
Square magnetic fastener white, magnetic force up to 5,6 kgs, with Klick adaptor and supergrip holder 75 mm, to insert and hold signs, crowners, cards etc. with up to 2 mm thickness. Strong hold guaranteed!

17421-00

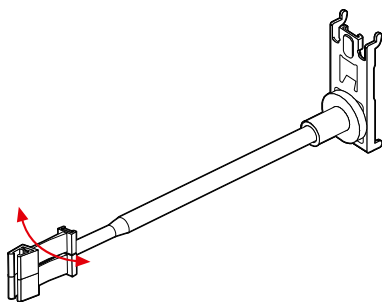

**SHOPPER STOPPER FOR PEG BOARD**  
To attach to peg boards with hole centres at 30 mm (corresponds to European standard), fixed chromium tube 310 mm and elastic frame clips. The frame (series 100) is held safely and swings back into its original position (please order separately).

17450-03/0310



## SHELF EQUIPMENT

### BANNER HANGERS



**BANNER HANGER, HORIZONTALLY ADJUSTABLE**  
 Horizontally adjustable banner hanger, with round magnet (zinc-coated) Ø 50 mm, alu tube with end cap grey, length 730 mm, incl. 2 tube hooks Ø 16 mm, clear. Special feature: black screw (M6 x 20) to level out differences in height of max. 10 mm. Maximum banner weight: 7 kgs.

26673-00/0730



**BANNER HANGER WITH MAGNET**  
 Magnetic base white 60 x 35 mm with hinge, alu tube Ø 10 mm, length 250 resp. 400 mm, end cap white. Suspensions accessories to be ordered separately.

banner hanger 250 | 26570-01/0250  
 banner hanger 400 | 26570-01/0400



**BENT BANNER HANGER WITH MAGNETIC BASE**  
 Magnetic base white 60 x 35 mm with hinge, bent alu tube Ø 10 mm (height 70 mm), length 250 mm, white end cap. Suspensions accessories to be ordered separately.

26572-01/0250



**BANNER HANGER FOR TEGO UPRIGHTS**  
 Zinc-coated metal hook for Tego uprights, with alu tube Ø 10 mm, adjustable 400 - 750 mm, tube fixing grey, white end cap. Suspensions accessories to be ordered separately.

26580-00/-0750



**BANNER HANGER FOR SHELF UPRIGHTS**  
 Adjustable clamp made of zinc-coated metal, suitable for different shelf uprights with rectangular slots, alu tube adjustable 400-750 mm, tube fixing grey, white end cap. Suspension accessories to be ordered separately.

26585-00/-0750





## SHELF EQUIPMENT BANNER HANGERS

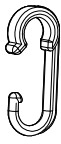

**TUBE HOOK TIGHT**  
For a secure and tight suspension of poster pockets, banners, punched category signs, etc. for tubes Ø 10 mm. Colors: grey, clear.

21340-xx/D10



**TUBE HOOK (RING)**  
For a secure suspension of promotion banners, punched category signs, poster pockets, etc., with ring Ø 10 mm, clear.

21355-00/D10



**PETG-FLAGPOLE**  
Bent holder made of PETG, 1,0 mm. Size (W x H x D): approx. 880 x 31 x 12 mm, to suspend flags, banners etc. from banner hangers and tubes with Ø 10 mm, oscillation by gravity. Suitable for banner hangers on prior page, incl. screw and rubber ring (black) as sliding prevention.

21345-00

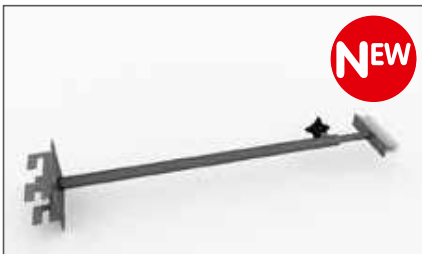

**UNIVERSAL SIGN HOLDER**  
To be fixed to Tego-holms or for universal fixing with screws. Material: polished zinc-coated steel. Length: approx. 350 mm, adjustable up to 600 mm. Front with welded-on plate and flexible display holder (75 mm), for signs of maximal 2 mm thickness. Available upon request.

26686-91/-600



**BENDED BANNER HANGER R100**  
Bent, massive alu profile 300 x 300 mm with 2 white magnetic fasteners, magnetic force up to 5,6 kgs and 2 clear suspension hooks. Profile suits frame accessories (series 100).

26675-01/0300

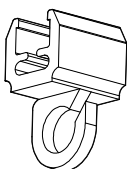

**SUSPENSION HOOK FOR BANNER HANGER R100**  
Hook 90° (for Ø 9 mm) to suspend punched posters, banners, etc., clear.

21333-00



## SHELF EQUIPMENT

### SHOPPER STOPPER FOR SCANNER RAILS

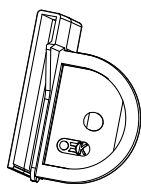

**SHOPPER STOPPER HR**  
To insert into scanner rails, for punched crowners, cards or signs with up to 1 mm thickness, clear. Punching at 10 mm.

height 39 mm | 17403-00  
height 53 mm | 17404-00

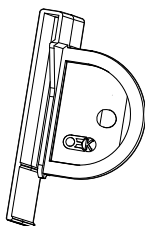

**SHOPPER STOPPER ME**  
Punching at 12 mm.

height 39 mm | 17405-00  
height 53 mm | 17406-00

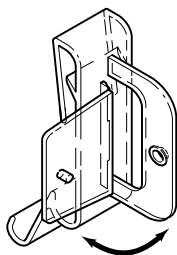

**SHOPPER STOPPER D**  
Fitting onto various scanner rails 30 and 39 mm high to hold punched stoppers, crowners and cards with up to 1 mm thickness. Punching at 12 mm. With hinge for easy change of stoppers, clear. PU: 100 pcs.

17401-00



**SPRING CLIP**  
To be fixed onto scanner rails 39 mm, to take signs, cards etc. with max. 0,2 - 0,6 mm thickness, polished stainless steel.

28050-00

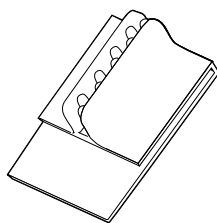

**SHOPPER STOPPER SC**  
To insert in scanner rail with 39 mm height, for cards with max. 0,3 - 0,6 mm thickness, 90° position to the shelf, clear.

17400-00

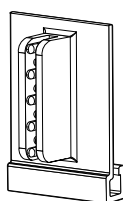

**SHOPPER STOPPER B**  
To clip onto the bottom edge of scanner rails, tight fitting for a guaranteed secure position, to take cards with max. 0,3 - 0,6 mm thickness, clear.

17402-00



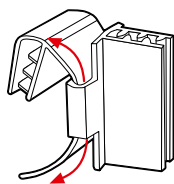

FLEXIBLE SHOPPER STOPPER  
SUPERGRIP

For fixing onto scanner rails, sign holder adjustable in 90° angle, to take signs, crowners etc. with up to 2 mm thickness, clear. PU: 100 pcs.

28011-00

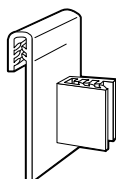

SHOPPER STOPPER SUPERGRIP

For fixing onto scanner rails, to take signs, crowners, etc. with up to 2 mm thickness, clear. PU: 100 pcs.

28010-00/20

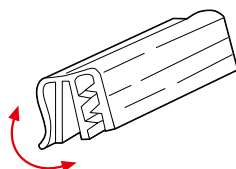

PARALLEL SHOPPER STOPPER  
SUPERGRIP

For parallel fixing onto scanner rails, to take signs, crowners, etc. with up to 2 mm thickness, length 25 mm with hinge, clear. PU: 100 pcs.

28012-00/25

SWIVEL-CARDHOLDER 35  
WITH MINI MAGNET

Swivel-cardholder 35 mm clear to take crowners, signs, etc. with max. 0,5 mm thickness, set with 2 mini magnets.

28438-00



SWIVEL-CARDHOLDER 35  
WITH SUCTION CUP

Swivel-cardholder 35 mm clear to take crowners, signs etc. with max. 0,5 mm thickness, set with suction cup Ø 45 mm.

28439-00

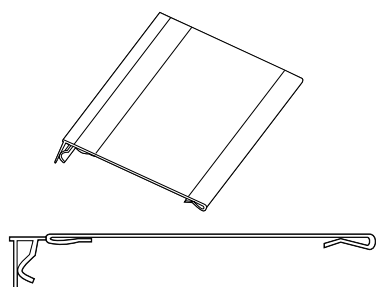

PARALLEL SHOPPER STOPPER WITH HINGE  
To fix into scanner rails, color: clear.

- A7 (landscape) | 49500-00/0105
- 148 x 110 mm (landscape) | 49501-00/0148
- 298 x 110 mm (landscape) | 49501-00/0298
- A6 (portrait) | 49502-00/0105



## SHELF EQUIPMENT

### SHOPPER STOPPER / SHOPPER WOBBLER

WE OFFER A VARIETY OF POSSIBILITIES FOR PRESENTING YOUR ADVERTISING MESSAGE – IN THE SHELF OR CHECKOUT AREA.

- shopper wobbler - starts moving with the slightest air flow
- shopper stopper - protruding from the shelf
- easy to hook in the scanner rails
- guides the customers' eyes straight to the product

- Material:
- unplasticized PVC, white or transparent
  - thickness: 0,3 mm - 0,5 mm
  - printed, shaped and folded

- Print:
- UV offset printing: bright, brilliant, scratch-proof gloss finish
  - Screen printing: well covering, durable and UV-resistant
  - Digital printing: ideal for customized prints ordered in smaller quantities

We also supply shopper wobblers or shopper stoppers for your individual applications providing you maximum freedom of choice with regard to material, size, shape, color and effects. Just contact us. We will be happy to advise you personally!

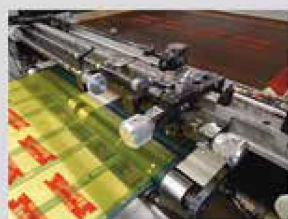

PRINTING



PUNCHING



EDGE BENDING





Shopper wobbler round, square or in special shapes



Shopper stopper standard, punched out with viewing window or with transparent viewing windows



Shopper stopper for ESL price displays



Special shopper stopper: with clips made by Oechsle



THE UNBEATABLE DUO

## SHELF EQUIPMENT

### DELICATESSEN & COUNTER MARKING



## PRICE CASSETTES – OFFERING VARIOUS OPTIONS TO MARK YOUR FRESH FOOD

### PRICE CASSETTES

For the price marking of delicatessen, fine food as well as fruits and vegetables our price cassettes offer a wide range of possibilities. Already equipped with ready-to-use folded number strips the closed cassettes allow for a clean, quick and informative marking of your fresh food and gourmet products.

For fixing the cassettes you can use all elements of the Klick accessories (series 300) which are specified in the chapter shelf promotion.

#### Remark:

We also supply customized folded number strips, labels etc. designed and manufactured according to your specific requirements for contents, word art, language etc.

Just send us your inquiry.

Prints and customized versions are our special strengths.

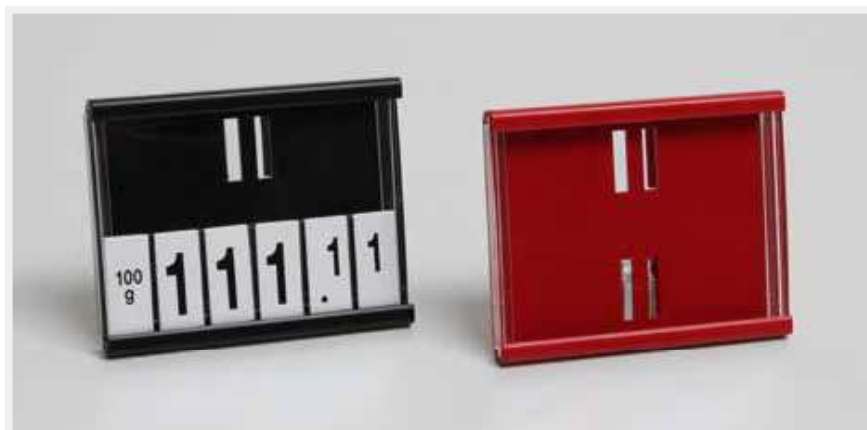

### PRICE CASSETTE DELICATESSEN A8

Price cassette with 2 different rear adaptors: one suitable for OEK Klick accessories (series 300) and the other for accessories of other producers. With 6-digit number strips (3 large, 2 small numbers, with unit/weight information, bilingual German/English, no wording), white PVC printed black, 2-parts mounted, cover clear, colors of body: white, red and black. PU: 25 pcs.

with number strips | 13205-xx  
for wording | 13208-xx  
(without inlays)



PRICE CASSETTE QP 7760

Price cassette with rear Klick adaptor, with 6-digit number strips (3 large, 2 small numbers with unit/weight information, bilingual German/English, no wording). White PVC printed black, assembled, colors of body: white, rape yellow, traffic red, black. PU: 25 pcs. Available upon request.

13249-xx

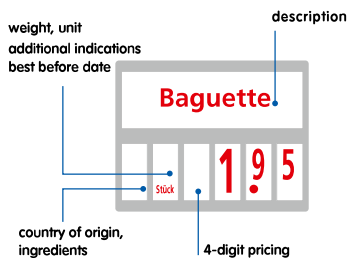

PRICE CASSETTE QP 7760

“SPECIAL EDITION”

For specific price marking of bread/bakery, meat/sausage, cheese, sea food, etc. (containing specific additional product information about ingredients, origin, etc). Available upon request.

1324x-xx



VISIONLINE KLICK ADAPTOR WITH CLAMP “VISION 58”

Using the Klick adaptor, all price cassettes and Klick shelf barkers can be combined with the range of Visionline elements. Set consisting of Visionline Klick adaptor (white) and clamp Vision 58 (clear).

28437-00



## SHELF EQUIPMENT

### DELICATESSEN & COUNTER MARKING

#### PRICE TAGS

Use the open, medium-sized price cassettes and displays with folded number strips and spiral blocks for convenient and flexible price labeling in the counter area.

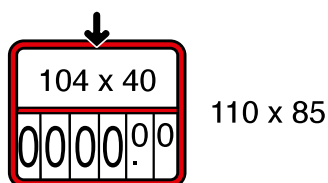

Printed goods labels are available upon request.

**PRICE BARKER TPS 110 X 85 MM**  
Made of high-grade plastic, for 6-digit number strips, with rear Klick adaptor. Colors: white, red, green, black. Outside dimensions 110 x 85 mm, size for wording 104 x 40 mm, without number strips, wording and clear PVC protective cover. Available upon request.

13191-xx

**PVC PROTECTIVE COVER**  
PVC cutting 104 x 40 mm, clear. Available upon request.

PVC protective cover | 24145-00



**FOLDED NUMBER STRIPS FOR TPS 110 X 85 MM**  
Made of white PVC printed black with 2 small and 4 large digits or large digits only, sheet with 3 number strips 214 x 14,5 mm each. Available upon request.

24105-00

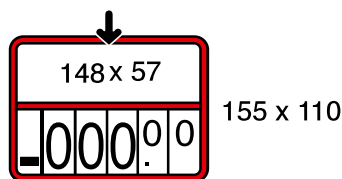

Printed goods labels are available upon request.

**PRICE BARKER TPS 155 X 110 MM**  
Made of high-grade plastic, for 6-digit number strips, with rear Klick adaptor. Colors: red, green. Outside dimensions 155 x 110 mm, size for wording 148 x 57 mm, without number strips and wording. Available upon request.

13192-xx

**FOLDED NUMBER STRIPS FOR TPS 155 X 110 MM**  
Made of white PVC printed black with 2 small and 3 large digits or large digits only and additional information such as weight, piece etc., sheet 269 x 129 mm with 6 number strips 269 x 21,5 mm each. Available upon request.

small and large digits | 24126-00  
large digits only | 24126-01







**NEW**

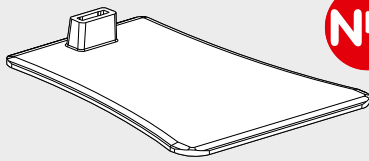

**FK-FIX BASE**

Plastic base to take FK-Fix rods. Rods can also be used 180° swiveled. Colors: clear, white, black (other colors are available upon request).

23970-xx

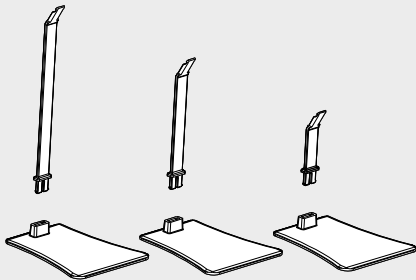

**FK-FIX ROD**

To be combined with FK-Fix base, inclined 30° from height of Klick adaptor. Colors: clear, white, black (other colors are available upon request).

- 50 mm | 23975-xx
- 100 mm | 23977-xx
- 150 mm | 23979-xx

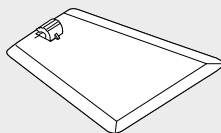

**FK BASE**

Plastic base with adaptor to take FK rods 50, 100 and 200 mm. Colors: clear, white, black.

23900-xx

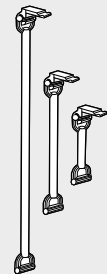

**FK ROD**

With Klick adaptor, to be combined with FK base, tray clip or universal clip. Colors: clear, white, black.

- 50 mm | 23905-xx
- 100 mm | 23910-xx
- 200 mm | 23920-xx



**FK CONNECTOR**

To connect e.g. universal or tray clip with price barkers or price cassettes. Colors: clear, white, black.

23940-xx

## SHELF EQUIPMENT

### DELICATESSEN & COUNTER MARKING

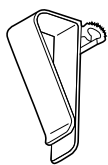

#### FK UNIVERSAL CLIP

For an universal attachment of Klick frames, etc. with rear Klick adaptor, to be combined with FK rods or FK connector.  
Colors: white, clear, black.

23960-xx

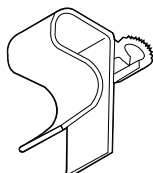

#### FK TRAY CLIP

To attach Klick frames etc. to trays and bowls, to be combined with FK rods or FK connector. Colors: white, clear, black.

23950-xx



#### MINI-CARDHOLDER

To hold small signs and labels made of paper, carton, etc. with a thickness of 0,3 - 1,3 mm and a max. size of 100 x 80 mm, width 25 mm. Colors: white, black. To be used with Klick accessories or standing alone as support.

17010-xx

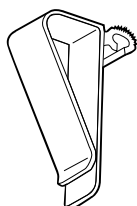

#### MINI-CARDHOLDER WITH UNIVERSAL CLIP

Delicatessen clip for general use, consisting of Mini-cardholder and universal clip. Colors: white, black. Not assembled.

36010-xx

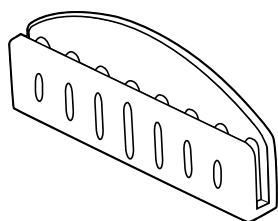

#### CARDHOLDER

To hold signs made of paper, carton, etc. with a thickness of 0,3 - 1,0 mm, width 60 mm. Colors: clear, white, grey, black. To be used with Klick accessories.

17000-xx

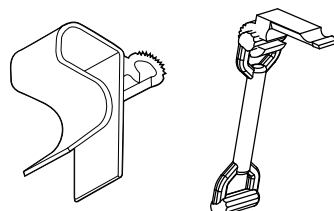

#### CARDHOLDER WITH TRAY CLIP

Clip to fit delicatessen trays, bowls, etc., consisting of cardholder, FK rod and tray clip. Colors: clear, white, black. Not assembled.

36000-xx



#### CARDHOLDER WITH FK ROD

Set consisting of cardholder 60 mm with FK rod and FK base. Colors: clear, white, black.

with FK rod 50		36030-xx
with FK rod 100		36031-xx
with FK rod 200		36032-xx



CLAMPHOLDER WITH FK ROD

Set consisting of clampholder Klick 100 mm, FK rod and FK base. Can take signs and cartons up to 5 mm thickness. Color: clear.

- with FK rod 50 | 36035-00
- with FK rod 100 | 36036-00
- with FK rod 200 | 36037-00

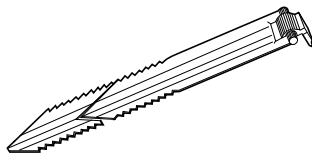

ICE STICK "KLICK"

To be used in fish counters with crushed ice, length 150 mm, breakable to 110 mm, clear.

23065-00



ICE-STICK "KLICK" WITH MINI-CARDHOLDER

To be used in fish counters with crushed ice, length 150 mm, breakable to 110 mm, clear. Set with mini-cardholder in clear or black.

36200-00/xx



CHALK BOARD "FISH"

PVC slate 0,5 mm, both sides slate coated and printed with 1 color, size 130 x 100 mm, black. Further sizes and customized printing available upon request.

30102-0005/05

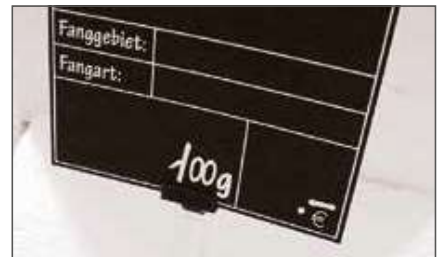

CHALK BOARDS

Made of polystyrene, both sides slate coated, for showcard frames of same size, thickness 0,95 mm, rounded edges, black.

Please note: These chalk boards are not heat-resistant. An exposure to direct sun light for example may lead to a deformation of the boards. For heat-resistant chalk boards see page 194.

- A8 | 30012-A8/095
- A7 | 30012-A7/095
- A6 | 30012-A6/095

Other sizes available upon request.



CHALK BOARD MARKER

To directly write on chalk boards, water soluble, white. PU: 8 pcs. per size.

- 5 mm | 24281-01
- 15 mm | 24280-01



## SHELF EQUIPMENT

### DELICATESSEN & COUNTER MARKING



**HOLDER FOR LAMINATED SIGNS**  
 Bent PVC 0,5 mm, for signs up to max. 1 mm thickness, angle approx. 80° (suitable chalk boards please see page 303), PU: 50 pcs. in poly bag.

holder for laminated signs (55 x 43 x 20 mm)		29900-0003/05
height 25 mm (60 x 68 x 25 mm)		29900-0001/05
height 70 mm (60 x 68 x 70 mm)		29900-0002/05
height: 90 mm (60 x 68 x 90 mm)		29900-0004/05

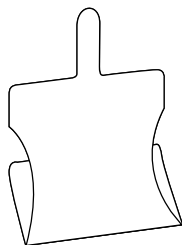

**PVC L-SUPPORT**  
 Suitable for price cassettes delicatessen A8 (or OEK Klick frames), clear. PU: 25 pcs.

5 cm		17211-00
10 cm		17210-00

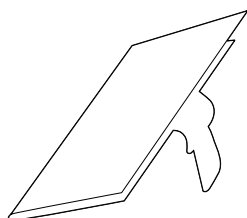

**PVC SUPPORT**  
 Suitable for price cassettes delicatessen A8 (or OEK Klick frames), used to give additional information at the rear for sales staff, label size 65 x 45 mm, clear. PU: 25 pcs.

17110-00

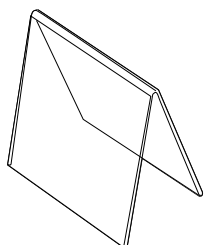

**PVC COUNTER SUPPORT DOUBLE**  
 For double sided insert of advertising or promotional price information, size 65 x 60 mm, made of bent PVC, clear. PU: 25 pcs.

29521-0006/10

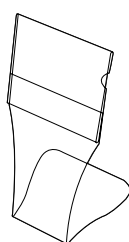

**PVC COUNTER SUPPORT PORTRAIT**  
 To insert advertising or promotional price information, size 65 x 60 mm, total height: 80 mm, made of bent PVC in slightly declined L-shape, clear. PU: 25 pcs.

29720-0006/10



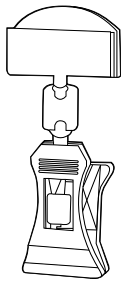

CARDHOLDER "VISION 27" WITH CLAMP

Set consisting of small cardholder 27 and small clamp 36 with connector.

without rod		28400-00
with rod 50 mm		28400-00/050
with rod 100 mm		28400-00/100

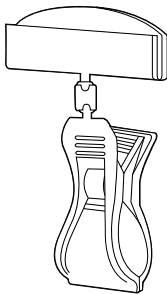

CARDHOLDER "VISION 50" WITH CLAMP

Set consisting of large cardholder 50 and big clamp 58 with connector.

without rod		28410-00
with rod 50 mm		28410-00/050
with rod 100 mm		28410-00/100

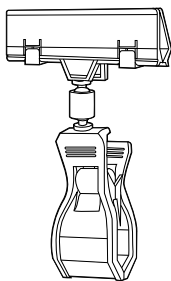

CLAMPHOLDER "VISION 80" WITH CLAMP

Set consisting of clampholder 80 and big clamp 58 with connector.

without rod		28420-00
with rod 50 mm		28420-00/050
with rod 100 mm		28420-00/100

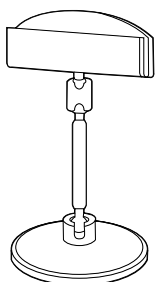

CARDHOLDER "VISION 50" WITH ROUND BASE

Set consisting of large cardholder 50 and round base Ø 50 with connector.

without rod		28430-00
with rod 50 mm		28430-00/050
with rod 100 mm		28430-00/100



## SHELF EQUIPMENT

### DELICATESSEN & COUNTER MARKING

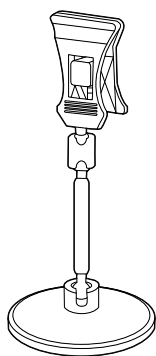

#### CLAMP "VISION 36" WITH ROUND BASE

Set consisting of small clamp 36 and round base Ø 50 with connector.

without rod | 28435-00  
with rod 50 mm | 28435-00/050



#### CLAMP "VISION 36" WITH RECTANGULAR BASE

Set consisting of small clamp 36 and rectangular base 50 x 75 mm with connector.

without rod | 28436-00  
with rod 50 mm | 28436-00/050

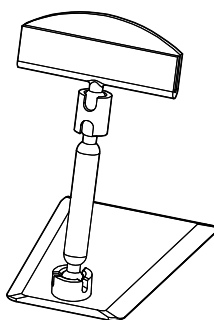

#### CARDHOLDER "VISION 50" WITH RECTANGULAR BASE

Set consisting of large cardholder 50 and rectangular base 50 x 75 mm with connector.

without rod | 28440-00  
with rod 50 mm | 28440-00/050  
with rod 100 mm | 28440-00/100

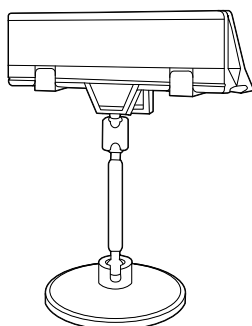

#### CLAMPHOLDER "VISION 80" WITH ROUND BASE

Set consisting of clampholder 80 and round base Ø 85 mm with connector.

without rod | 28490-00  
with rod 50 mm | 28490-00/050  
with rod 100 mm | 28490-00/100



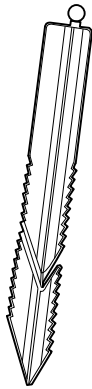

ICE-STICK 150 "VISION"  
With Visionline ball joint for combination with cardholder and clampholder Vision, length 150 mm, breakable to 110 mm, clear.

28110-00

ICE-STICK "VISION 80" WITH CLAMPHOLDER  
Set consisting of clampholder 80, Ice-Stick 150 Vision and connector.

28433-00

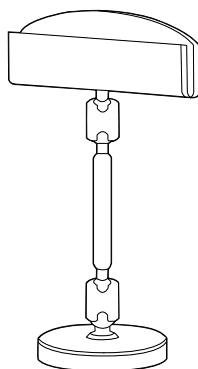

CARDHOLDER "VISION 50" WITH MAGNET  
Set consisting of large cardholder 50 and big magnetic base Ø 32 mm with connector.

without rod		28470-00
with rod 50 mm		28470-00/050
with rod 100 mm		28470-00/100

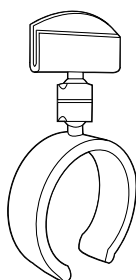

CARDHOLDER "VISION 27" WITH RING  
Set consisting of small cardholder 27 mm clear with ring and connector white. For price marking right at the product (e.g. in sausages counters).

with ring 30 mm		28471-00/30
with ring 40 mm		28471-00/40
with ring 50 mm		28471-00/50
with ring 70 mm		28471-00/70
with ring 90 mm		28471-00/90



## SHELF EQUIPMENT

### DELICATESSEN & COUNTER MARKING

**SIGNHOLDER SUPPORT SWIVEL-TYPE**  
Small support with cardholder 25 mm clear to take light signs, small cards, etc. with thickness up to 0,5 mm. Adjustable viewing angle. Size: 38 x 30 mm.

17020-00

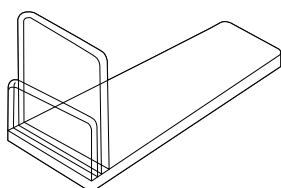

**LYING CARDHOLDER**

To hold small price and promotion cards, etc., slot width 0,5 mm. Size: 42 x 24 mm, clear.

36700-00



**PLANT STICK 150 WITH CARDHOLDER**

To stick into planting dish, rod with Klick adaptor length 150 mm breakable to 110 mm, set complete with cardholder, moss green.

36220-6005



**PLASTIC STAKE 90 MM WITH CARDHOLDER FK**

Set consisting of plastic stake 90 mm and cardholder FK, black for signs 0,1 - 0,8 mm thickness.

36300-26/10

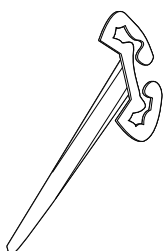

**PLASTIC STAKE FOR PRICE CARDS**

To fix small price and promotion cards, etc., with max. 1 mm material thickness, length approx. 50 mm, white.

23840-01







**NEW**

CLAMPHOLDER FOR SIGNS,  
60 X 45 MM

To fix signs, not suitable for chalk boards.  
Sizes approx. 4,5 x 6,0 cm (W x H). Color:  
green. Other colors available upon  
request. PU: 10 pcs.

17260-07

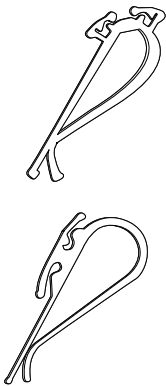

UNIVERSAL CLIP FOR PRICE CARDS

To fix small price and promotion cards,  
chalk boards etc., with thickness up to  
1 mm, onto delicatessen bowls max.  
10 mm thick. Size: 15 x 60 mm, white.

inclined | 17250-01

upright | 17255-01

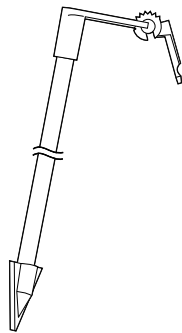

STAKE

Aluminium tube Ø 6 mm, in lengths 200,  
400, 600 and 800 mm, other lengths avail-  
able upon request. With plastic stake and  
adjustable Klick adaptor. To be combined  
with Klick shelf barkers, cardholder, etc.

stake 200 | 38401-91/6/200

stake 400 | 38401-91/6/400

stake 800 | 38401-91/6/800

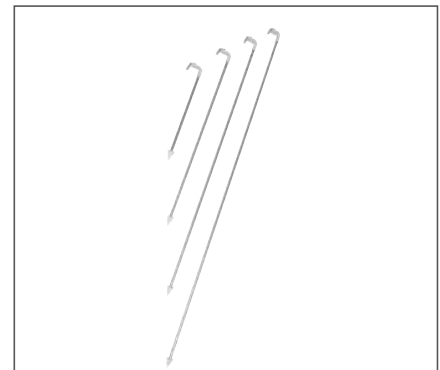

STAKE WITH CARDHOLDER

Aluminium tube Ø 6 mm in lengths 200,  
400, 600 and 800 mm, other lengths  
available upon request. With plastic stake  
and cardholder grey.

stake 200 with cardholder | 36101-03/200

stake 400 with cardholder | 36101-03/400

stake 600 with cardholder | 36101-03/600

stake 800 with cardholder | 36101-03/800



## SHELF EQUIPMENT

### DELICATESSEN & COUNTER MARKING

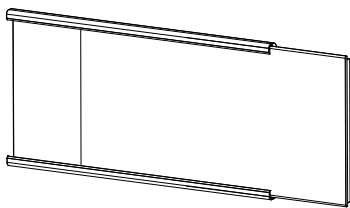

#### PRICE CASSETTE FOR FRUIT AND VEGETABLES 160 X 83 MM

Price cassette for printed inlays with clear cover (for pushing) for fruit and vegetables, with Klick adaptor for OEK Klick accessories as well as for accessories of other producers on rear side, colors: green, black.

71-13010-xx

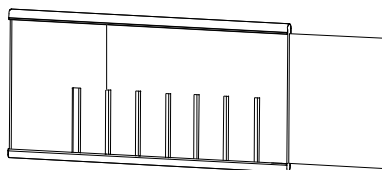

#### PRICE CASSETTE FOR FRUIT AND VEGETABLES 160 X 83 MM

Price cassette for printed inlays with clear cover (for pushing) for fruit and vegetables, with Klick adaptor for OEK Klick accessories as well as for accessories of other producers on rear side, assembled with numbers (slot 2-8), size 160 x 83 mm, colors: green, black.

numbers green on white, English or German		71-13100-xx/ENG or /DEU
numbers black on white, English or German		71-13110-xx/ENG or /DEU
numbers white on black, chalk style, English or German		71-13120-xx/ENG or /DEU



### LOCKING LEVER AND BLANK LABELS FOR PRICE CASSETTES O+G 160X83 MM

1. DIGITS "ADDITIVES" FOR FRUIT AND VEGETABLES PRICE CASSETTE 160 X 83 MM  
Digits "additives" for fruit and vegetables price cassette 160 x 83 mm, color: transparent, 20 sets / sheet.

print: white / chalk style, English or German		71-24130-01/ENG or /DEU
print: green, English or German		71-24130-07/ENG or /DEU
print: black, English or German		71-24130-10/ENG or /DEU

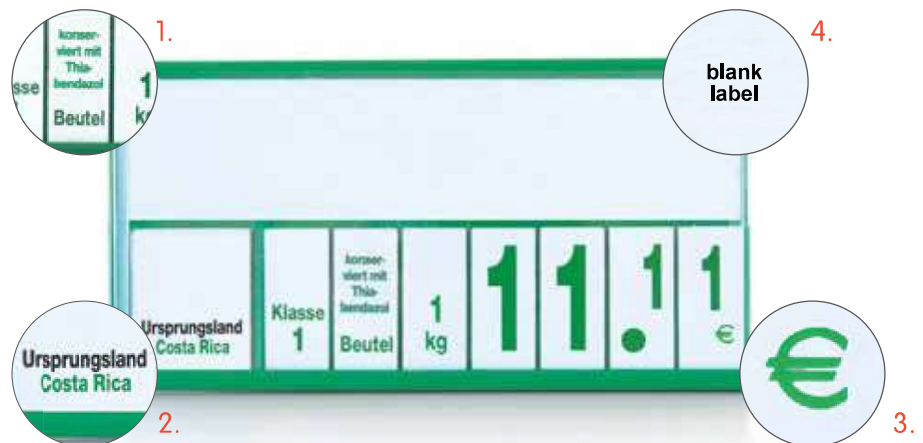

2. DIGITS "COUNTRIES OF ORIGIN" FOR FRUIT AND VEGETABLES PRICE CASSETTE 160 X 83 MM  
Digits "countries of origin" for fruit and vegetables price cassette 160 x 83 mm (for slot 1), 4 sets / sheet

Leporello print: white on black, chalk style, English or German		71-24120-01/10/ENG or /DEU
Leporello print: green/black on white, English or German		71-24120-07/10/ENG or /DEU

3. €-SIGN FOR FRUIT AND VEGETABLE PRICE CASSETTE 160 X 83 MM  
€-sign for fruit and vegetables price cassette 160 x 83 mm, color: transparent, 80 pcs. / sheet

print: white / chalk style		71-24110-01
print: green		71-24110-07
print: black		71-24110-10

4. BLANK LABELS FOR PRICE CASSETTES O+G 160X83  
Blank labels can be marked and printed manually with the help of a corresponding software. (for laser printing only)  
Size: approx. 155 x 40 mm.  
Delivered on pre-cut A4 sheets.  
Labels and software upon request.

71-24100-01

## SHELF EQUIPMENT

### DELICATESSEN & COUNTER MARKING



#### QP UNIVERSAL CLAMP

Very massive clamp to attach qP price cassettes, shelf barkers, etc. to boxes and baskets with thickness up to 30 mm. Klick adaptor with rotary ball-joint. Color: black.

17070-10

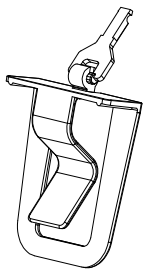

**NEW**

#### CARDBOARD CLAMP 70 WITH FK CONNECTOR 25

To attach onto baskets, boxes, etc., for material thickness up to 18 mm. Set consisting of cardboard clamp 70 and FK connector 25. Color: black.

Other colors available upon request.

35490-10

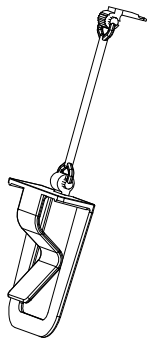

**NEW**

#### CARDBOARD CLAMP 70 WITH FK ROD

To attach onto baskets, boxes, etc., for material thickness up to 18 mm. Set consisting of cardboard clamp 70 and FK rod with Klick adaptor for combination with price cassettes, Klick shelf barkers, acrylic frames, ESL and many others.

Color: black.

Other colors available upon request.

with rod 50 mm		35492-10/050
with rod 100 mm		35492-10/100
with rod 200 mm		35492-10/200



#### PRICE DISPLAY PD 210 X 190 MM

Designed to be used at fruit and vegetable shelves, for 6-digit folded number strips, front with 2 inserts for wording (top 40 x 190 mm, bottom 55 x 190 mm), rear with additional adaptor for Klick accessories, color: green. Supplied without number strips, cutting for wording and PVC cover.

14280-07



#### FOLDED NUMBER STRIPS FOR PD A5 & PD 210 X 190 MM

Made of white PVC, printed black with small and large numbers, sheet size 418 x 180 mm with 6 strips 418 x 30 mm each.

24056-00

## SHELF EQUIPMENT

### DELICATESSEN & COUNTER MARKING / SIGNHOLDER



**SINGLE PLASTIC CASSETTE FOR SPIRAL BOUND NUMBER BLOCKS**  
Single plastic cassettes made of white polystyrene to create individual displays. Individual combinations are welded to PS boards with customized printing and additional plastic rails or PVC covers for promotional information. Single or double sided versions possible.

**Single Cassette**

40 x 80 mm | 24630-01  
72 x 80 mm | 24620-01  
76 x 181 mm | 24610-01



**PLASTIC CASSETTE FOR SPIRAL BOUND NUMBERS**  
Cassette made of polystyrene white, to create individual displays.

**Cassette with each 5 inserts**

203 x 93 mm | 24341-01  
203 x 125 mm | 24342-01  
290 x 170 mm | 24343-01  
410 x 225 mm | 24344-01  
296 x 125 mm (5+1 insert) | 24345-01

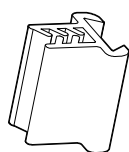

**KLICK GRIP 15**  
Suiting the range of the Klick accessories (series 300) this Klick grip is creating a super signholder range with fixing possibilities for almost every situation. Simply to put onto the dovetail guide of the various Klick elements - done.  
To take signs, crowners etc. with a max. thickness of 2 mm. Color: clear.  
PU: 100 pcs.

28003-00/0015

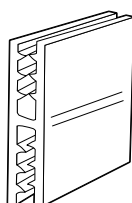

**DOUBLE HOLDER SUPERGRIP**  
"H" version to connect 2 signs, cards, crowners, etc. with up to 2 mm thickness, length 25 mm, clear. PU: 100 pcs.

28014-00/25

SHELF EQUIPMENT  
SIGNHOLDER

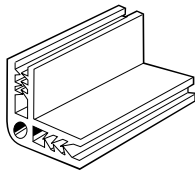

**L HOLDER SUPERGRIP**  
"L" version (90° angle) to connect 2 signs, cards etc. with up to 2 mm thickness, length 25 mm, clear. PU: 100 pcs.

28020-00

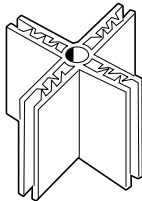

**X HOLDER SUPERGRIP**  
"X" version (90° angle) to connect up to 4 signs, cards etc. with up to 2 mm thickness, length 25 mm, clear. PU: 100 pcs.

28019-00

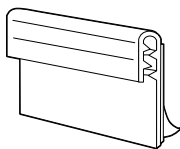

**SIGNHOLDER SUPERGRIP**  
To take signs, crowners, cards, etc. with up to 2 mm thickness parallel to the shelf, self adhesive, clear. PU: 100 pcs.

length 25 mm | 28015-00/25  
length 75 mm | 28015-00/75



**SIGNHOLDER FOR WIRES SUPERGRIP**  
To fix onto wires with up to Ø 7 mm, to take signs, crowners, cards, etc. with up to 2 mm thickness, clear. PU: 100 pcs.

28016-00/13

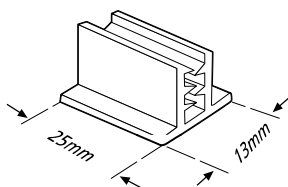

**DISPLAY HOLDER SUPERGRIP**  
To take signs, crowners, cards, etc. with up to 2 mm thickness, self adhesive, clear. PU: 100 pcs.

length 25 mm | 28013-00/25  
length 75 mm | 28013-00/75

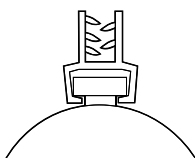

**SIGNHOLDER SUPERGRIP 25 MM WITH SUCTION CUP**  
Parallel, to take material with 0,2 - 1,3 mm, color: clear.

28024-00



## SHELF EQUIPMENT

### ACCESSORIES FOR PEG-BOARD HOOKS

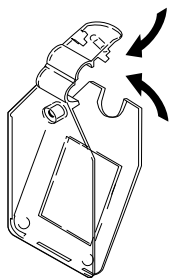

#### POCKET SWING TAG FOR PEG BOARD HOOKS

Pocket swing tag for peg board hooks, suitable for wire-Ø 4,8 mm. With clear snap pocket. PU: 100 pcs.

25 x 27 mm | 17301-00  
25 x 38 mm | 17300-00

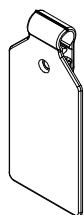

#### POCKET SWING TAG FOR PEG BOARD HOOKS

Pocket swing tag for peg board hooks, suitable for wire-Ø 4,8 mm, for use with adhesive labels only. Color: white. PU: 100 pcs.

for label size 25 x 25 mm | 17305-01  
for label size 25 x 38 mm | 17304-01

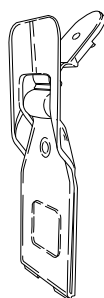

#### POCKET SWING TAG FOR DOUBLE HOOKS WITH ANTI-THEFT SYSTEM

Pocket swing tag for double hooks with anti-theft system 26 x 68 mm (suitable for wire-Ø 4,8 mm). Cost-saving anti-theft system for quality goods. With pocket for labels size 25 x 27 mm (W x H). PU: 100 pcs.

17320-00

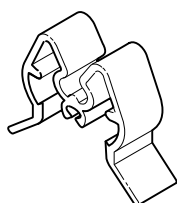

#### STOCK INVENTORY CLIP

Stock inventory clip for slatwall hooks, fitting onto single or double hooks with wire- Ø 4,8 mm, white. PU: 100 pcs.

49991-01



#### PENDULUM POCKET DRA 26

Scanner profile for peg board hooks with wires Ø 4,8 mm, 7 mm punching, for labels size 26 x 75 mm, clear. Other sizes available upon request. PU: 100 pcs.

49361-00/0075



#### PENDULUM POCKET DRA 39

Scanner profile for peg board hooks with wires Ø 4,8 mm, 7 mm punching, for labels size 39 x 75 mm, clear. Other sizes available upon request. PU: 100 pcs.

49364-00/0075

