

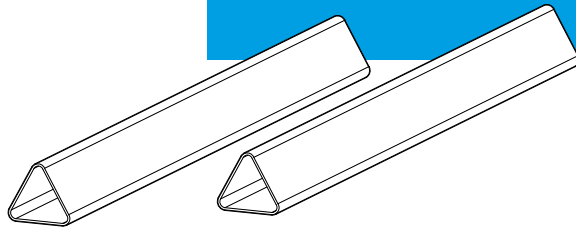

CHECKOUT AND SALES MARKING



CHECKOUT AND SALES MARKING

CHECKOUT DIVIDERS

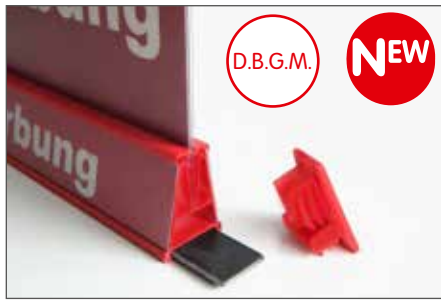

CHECKOUT DIVIDER TRAPEZOIDAL
Measurements (L x H x D): 305 x 140 x 35 mm.
Advertising opportunity on the flanks.
U-pockets are possible. Optionally
available with metal plate.
Colors and lengths upon request.
Available upon request.



CHECKOUT DIVIDER 30 X 30 MM RED
Measurements (LxHxD): 30x30x310 mm.
Advertising possibility with inserts size
309 x 23 mm. Incl. 2 end caps and 3 PVC-
strips transparent. Overlaying round edges
protect the divider from getting scratched.
Further colors and lengths upon request.

37010-00/310

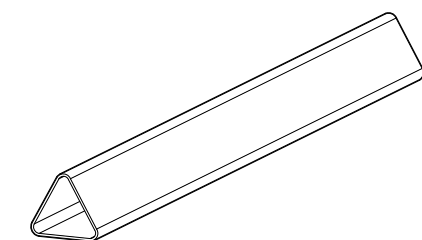

**CHECKOUT DIVIDER 30 X 30 MM
TRANSPARENT**
Measurements (L x H x D): 30 x 30 x 310 mm.
Advertising possibility with inserts. Other
colors and lengths upon request. End caps
to be ordered separately.

88-37000-00/300

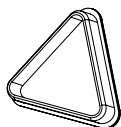

END CAP FOR CHECKOUT DIVIDER
To be put and glued sideways into the
checkout divider profile. Colors: white,
rape yellow, red, black. Further colors
available upon request.

84-15499-xx



**END CAP LARGE FOR CHECKOUT
DIVIDER**
To be stucked outside onto the divider.
Divider is laying only on the edges of the
end caps. Advantage: divider does not get
scratched. Colors: white, traffic red.

84-15497-xx



End caps are
protecting the divider
from getting scratched.

CHECKOUT AND SALES MARKING

CHECKOUT DIVIDERS/CASH TRAYS

CHECKOUT DIVIDER "WOOD"

Made of pure oak. Measurements: 300 x 30 x 30 mm. Individual logo print available upon request.

rectangular | 37021-00
triangular | 37020-00



CHECKOUT DIVIDER T

Made of massive wood natural beech with T-profile slot and 3 supergrips (to be inserted sideways), incl. 0,5 mm clear PVC poster protector 297 x 140 mm.

37030-00



CASH TRAY "WOOD"

Square cash tray made of pure oak, concave shaped with stoppers for a non-slip stand. Measurements: 140 x 140 x 20 mm. Individual logo print available upon request.

13289-00



CASH TRAY "K" 215 X 100 MM

Bended cash tray made of 2 mm acrylics with rubber pads for a non-slip stand. Insert (bottom size max. 96 x 215 mm - complete size max. 190 x 215 mm) available upon request, transparent.

13288-00



CASH TRAY "K" 205 X 170 MM

Cash tray made of high-grade unbreakable plastics with round corners and rubber pads for a non-slip stand. No inlay (adhesive foil or paper inlay), transparent.

13281-00

Individual print available upon request.



CHECKOUT AND SALES MARKING

CASH TRAYS

CASH TRAY "GLASS" 150 X 150 MM
Cash tray made of glass with round corners, round cash hollow and stoppers for a non-slip stand, crystal clear. No inlay.

13285-00

Individual print available upon request.



CASH TRAY "K" 180 X 180 MM
Cash tray made of high-grade unbreakable plastics, concave shaped with mitred corners and stoppers for a non-slip stand, transparent. No inlay.

13290-00

Individual print available upon request.



CASH TRAY WITH PRODUCT PRESENTATION

Cash tray with can display. For other products upon request. Material: acrylic, laser contour. Measurements: 355 x 249 x 106 mm. Other measurements upon request.

With elastic buffer on the bottom.
Text inlay included.

Available upon request.

Individual print available upon request.



REMARK:
Further types in different versions available upon request.



INFOLINE

The products from our series "INFOLINE" have been successfully used – for years! Wherever you need to display lots of information in a space saving way, INFOLINE is the best choice. Offering high quality, precise workmanship as well as a comprehensive standard range for increased flexibility this system provides the ideal solution for every application.

All INFOLINE "400" models with 5 delicate INFOLINE frames are equipped with a black plastic rear permitting to fix the frames in 3 different heights. The models with 10 frames are supplied with a grey metallic rear (not adjustable in height).

REMARK:

All SK bases are supplied with 2 hole drillings. For increased stability we recommend screwing them onto the desk.



INFOLINE W A4

For wall fixing, with 5 or 10 Infoline frames A4 in OEK standard colors or multicolored (color code = 00), incl. non-reflective PVC poster protectors, plastic rear black (for 10 frames metallic rear in grey). Total height 33 cm.

with 5 frames		39640-xx/5
with 10 frames		39640-xx/10



INFOLINE W WITH 5 FRAMES

For wall fixing, with 5 frames A5 in OEK standard colors or multicolored (color code = 00), incl. non-reflective PVC poster protectors, rear with 2 plastic profile angles black and aluminium connector. Total height 24 cm.

A5		39650-xx/5
A3		39630-xx/5



INFOLINE T

With 7 or 10 Infoline frames A4 in OEK standard colors or multicolored (color code = 00), incl. non-reflective PVC poster protectors, metallic L-shape stand, black. Total height: 35 cm.

with 7 frames		39200-xx/7
with 10 frames		39200-xx/10



CHECKOUT AND SALES MARKING

INFOLINE



INFOLINE T PLEXI

With 5 Infoline frames A4 in OEK standard colors or multicolored (color code = 00), incl. non-reflective PVC poster protectors, transparent plastic stand for use as table or counter version.

with 5 frames | 39250-xx/5

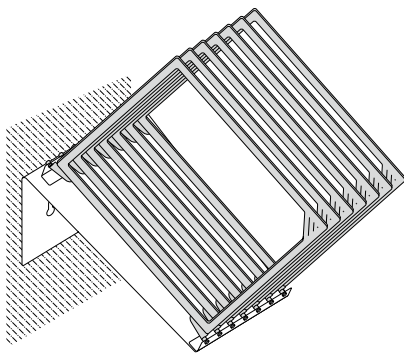

INFOLINE T/W A4

Infoline stand for table or wall, with 8 Infoline frames A4 in OEK standard colors or multicolored (color code = 00), incl. non-reflective poster protectors, metallic support grey inclined, L-shape. Total height: 30 cm.

with 8 frames | 39194-xx/8

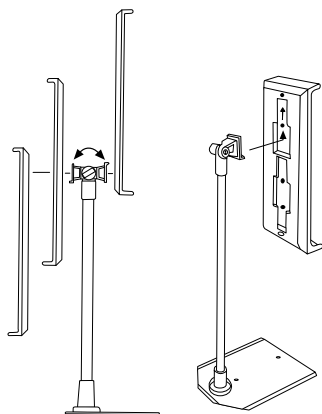

INFOLINE 401

With 5 or 10 Infoline frames A4 in OEK standard colors or multicolored (color code = 00), incl. non-reflective PVC poster protectors, SK base black, fixed aluminium tube 38 cm, 1 hinge with locking screw on the back.

with 5 frames | 39445-xx/5
with 10 frames | 39445-xx/10



INFOLINE 402

With 5 or 10 Infoline frames A4 in OEK standard colors or multicolored (color code = 00), incl. non-reflective PVC poster protectors, SK base black, fixed aluminium tube 38 cm, 2 hinges with locking screw (on the back and on base level).

with 5 frames | 39465-xx/5
with 10 frames | 39465-xx/10



INFOLINE 400A

With 5 or 10 Infoline frames A4 in OEK standard colors or multicolored (color code = 00), incl. non-reflective PVC poster protectors, SK base black, adjustable aluminium tube 40 - 70 cm, 1 hinge with locking screw on the back.

with 5 frames | 39405-xx/5
with 10 frames | 39405-xx/10



INFOLINE BD

With 5 Infoline frames A4 in OEK standard colors or multicolored (color code = 00), incl. non-reflective PVC poster protectors, BD base Ø 255 mm black, fixed aluminium tube 120 cm. Total height: 145 cm.

Infoline BD | 39490-xx/5



INFOLINE 500

With 5 frames A5 in OEK standard colors or multicolored (color code = 00), with extra browser clips, incl. non-reflective PVC poster protectors, SK base black, fixed aluminium tube 20 cm, 1 hinge with locking screw underneath the back. Total height: 52 cm.

Infoline 500 | 39500-xx/5



CHECKOUT AND SALES MARKING

INFOLINE

INFOLINE 300

With 5 frames A3 in OEK standard colors or multicolored (color code = 00), with extra browser clips, incl. non-reflective PVC poster protectors, SK base black, fixed aluminium tube 80 mm, 1 hinge with locking screw underneath the back.
Total height: 62 cm.

Infoline 300 | 39300-xx/5

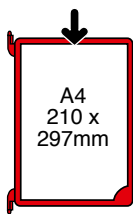

INFOLINE FRAME

Slim frame A4 with integrated browser clips and edge for easy grip. Suits all Infoline stands, in OEK standard colors.

A4 | 11406-xx
A3 (upon request) | 11306-xx

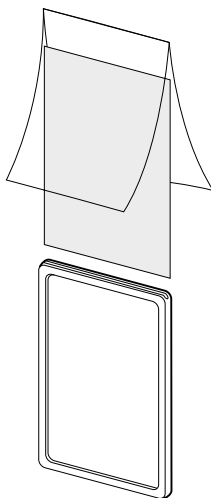

PVC POSTER PROTECTOR

Made of PVC 0,2 mm (A5 & A4), 0,3 mm (A3) folded on short side, non-reflective, clear.

A5 | 29100-A5/02
A4 | 29100-A4/02
A3 | 29100-A3/03

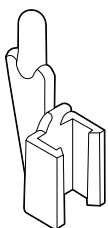

BROWSER CLIP

For swivel (A6 to A3) mounting of show-card frames series 100, to be used in Infoline models, clear.

21880-00



POSTERLINE STAND

Stable metallic stand, powder coated grey, with 10 frames A1 in OEK Standard colors with extra browser clips, incl. non-reflective PVC poster protectors.

Measurements approx. (W x H x D):
60 x 160 x 66 cm.

Delivered for self mounting.

39871-xx



POSTERLINE WALL

Metallic rear plates for wall fixing, powder coated grey, with 10 frames in OEK standard colors or anodized aluminium profile frames with extra browser clips, incl. non-reflective PVC poster protectors. Delivered for self mounting.

- | | | |
|-------------------------|--|----------|
| A1 (plastic frames) | | 39891-xx |
| A2 (plastic frames) | | 39892-xx |
| A1 (alu-profile frames) | | 39881-90 |
| A2 (alu-profile frames) | | 39882-90 |

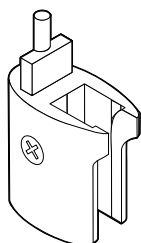

BROWSER CLIP WITH METAL-PIVOT

Very stable, screwed version with metal-pivot for frames series 200, to be used in Infoline and Posterline models, clear.

22890-00



CHECKOUT AND SALES MARKING

ADVERTISING ON SHOPPING TROLLEYS

BASKET DISPLAY – “ADVERTISING IN MOTION!”

Being suitable for almost all shopping trolleys, our basket display directs the attention of your customers straight to your advertisement. Take advantage of the possibility to present your advertising message on both sides.

The more information you give, the better you are able to sell!

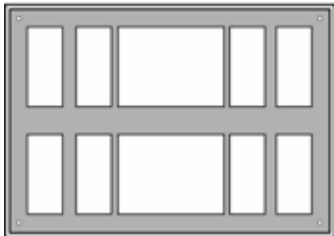

BASKET DISPLAY FOR SHOPPING TROLLEYS - A4 LANDSCAPE (PAIR)

To be attached by plastic clips or screws, with drain slots for rain water. For posters with up to 1,8 mm thickness. Colors: traffic red, black. Further colors available upon request.

with clip fixing | 18040-xx

with screw fixing | 18040-xx-M



PVC CUTTING

Suits grip and basket display, to protect your advertising and sales information, non-reflective PVC, thickness 0,2 mm, clear.

29000-A4/02



SHOWCARD FRAME 252 X 195 MM FOR SHOPPING TROLLEYS - LSE

Made of high-grade unbreakable plastics, specially designed for attachment onto shopping trolleys (outside or inside), fixing set to be ordered separately. Color: red.

11405-06



FIXING SET FOR SHOPPING TROLLEY FRAME

For attachment of standard showcard frames (series 100) onto shopping trolleys, 4-parts set, clear.

21432-00



PVC POSTER PROTECTOR 252 X 195 MM - LS

Suits showcard frame 252 x 195 mm for shopping trolleys, to protect your advertising and sales information, non-reflective PVC, folded long side, thickness 0,3 mm, clear.

29101-0005/03

GRIP DISPLAY – NEVER BEFORE YOU HAD SUCH A LONG-LASTING GRIP ON YOUR CUSTOMER!

Guide your customers through the colorful world of offers – single minded and efficiently: The grip display at the shopping trolley is the ideal means of communicating your adverts, special offers, general information such as “Where to find?” and all kind of brand promotion.

The perfect positioning guarantees that your message won't be missed – that's for sure!

GRIP DISPLAY A5 LANDSCAPE

2-parts anodized aluminium profile with 2 plastic end caps. Colors: available upon request. Suitable for shopping trolleys either with round or panoramic grip. External size: 220 x 163 mm. Transparent PVC-cover to be ordered separately (not included).

round grip | 18020-xx
panoramic grip | 18021-xx



SHOPPING BASKET

Made of plastic, 1 handle, 20 liters. Measurements: 300 x 230 x 430 mm, color: red. Further colors upon request. Logo print upon request.

18055-xx



KIOSK FLAGPOLE

Holder made of premium plastics, silver, with self-adhesive foam pad, in a 70° angle, slotted aluminium tube Ø 18 mm, length 800 mm. Set incl. hardware for wall fixing. Available upon request.

26695-91/9007

